

Installation Manual

 **octave**

Ultrasonic Water Meters



24573010

1.0 General and Safety

- Do not install, operate or maintain this flow meter without reading, understanding and following the factory-supplied instructions. Otherwise, injury or damage may result.
- Read these instructions carefully before beginning installation and save them for future reference.
- Observe all warnings and instructions marked on the product.
- Consider handling and lifting instructions to avoid damage.
- If the product does not operate normally, refer to the service instructions or to a qualified ARAD service engineer.
- There are no operator-serviceable parts inside this product.

2.0 Product Liability and Warranty

3. Arad's standard products (the "Products") are sold to Customer and are purchased by Customer under the terms of warranty set forth herein below:
4. Arad warrants that the Products shall, under conditions of normal use and when properly installed, administered, applied and maintained, be free from defects in material and workmanship (the "Warranty"), for a period of 12 months following delivery thereof to Customer (the "Warranty Period").
5. Arad's sole obligation and liability under the Warranty shall be limited to the replacement, the repair or the refund of the original purchase price, at Arad's sole discretion, of any defective Products which are proven not to conform to the Products' specification and which are returned to the factory or service center designated by Arad during the Warranty Period by the Customer after completing a failure report. All provided that written notice of such defect is given by the Customer to Arad within 21 days after discovery thereof. Freight cost to such factory or service center will be paid by the Customer and freight cost from such factory or service center to Customer will be paid by Arad.
6. Arad will not be responsible for and will have no obligation under the Warranty to any non-conformity of the Products, caused, in whole or in part, as a result of misuse, abuse, tampering with or modification of any of the Products and/or by accidents, fault or negligence, improper administration, application and/or use, installation, service, repair and/or maintenance of the relevant Products, by act of vandalism or by any causes whatsoever (including but not limited to environmental conditions) that are external thereto.
7. The foregoing warranty is a limited warranty and is exclusive and in lieu of all other warranties, express or implied, including, but not limited to, the implied warranties of merchantability and fitness for a particular purpose and shall constitute the Customer's sole and exclusive remedy with respect thereto. Replacement or repair in the manner provided above will constitute fulfillment of all of Arad's obligations with respect to the quality and performance of the products. No dealer, distributor, agent or employee of either Arad or customer is authorized to modify these warranties. Such modification shall be null and void and shall not bind Arad for any and all purposes.
8. Except and to the extent provided under the warranty, in no event shall Arad be liable, whether in contract, tort or otherwise, for any damages, whether direct or indirect, consequential, incidental, special or punitive, resulting from any defect in the products, including, without limitation, loss of profits, business, income, anticipated savings, goodwill or other commercial loss, even if Arad had been advised of the possibility of such damages, except to the extent that such liability may not lawfully be excluded.

Customer shall be solely responsible for the selection, use, efficiency and suitability of the Products.

3.0 Items Included With Order:

- One OCTAVE ultrasonic flow meter, size as indicated on the packaging box, pieced together into a complete compact system (flow tube plus electronics).
- One OUTPUT module, either digital or analog (based on the customer's order).

4.0 Supplied Documentation:

- Condensed installation and user manual.
- Report of factory meter settings.
- Certificate of calibration data.

5.0 Unpacking and Inspection

- This product has been thoroughly inspected and tested before shipment and is ready for operation.
- After carefully unpacking the meter, inspect for shipping damage before attempting to install. If any indication of mechanical damage is found, immediately contact the responsible transportation service and your local ARAD LTD. representative.

6.0 System Description and Measurement Method

- The OCTAVE's measurement method is based on an ultrasonic, transit-time, dual-beam sensors which determines the length of time it takes an ultrasonic sound wave to travel the distance between the two sensors located on the meter's body. The sensors function as both the sender and the receiver, each one alternating these functions so that the ultrasonic wave travels both with and against the direction of the flow. Since the ultrasonic wave travels slower against the flow than with the flow, the time difference of two waves traveling with and against the flow leads to determining the velocity of the water.
- The OCTAVE ultrasonic flow meter is a battery-powered precision flow meter designed for linear, bidirectional flow measurement of water.
- Flow measurement values can be transferred through the standard communication - digital or analog output.
- The OCTAVE can be set up for a wide range of applications.

7.0 Notes

- For proper flow measurements, the OCTAVE's measuring tube should be completely full at all times. Non-wetted sensors show loss of signal. Though this will not cause damage to the meter, it will, however, not measure flow and display zero.
- Flow direction: The OCTAVE is a bidirectional flow meter. Note the indicating arrow on the OCTAVE's display for forward and backward flows.
- In case of direct sunlight exposure, it is recommended to keep the lid closed, though no direct damage will occur with the lid open.
- Do not expose the OCTAVE to excessive vibration. To avoid vibration, support the pipeline on both side of the meter
- Ambient working temperature: -25 to +55°C.
- Water working temperature: 0.1 to +50°C.
- To avoid measuring errors due to air in the flow tube, observe the following precautions:
- Since air collects at the highest point of the system, installation of the flowmeter should be at the lowest point.
 - Always install control valves downstream of the meter in order to avoid cavitation.
 - Never install the meter on a pump suction side in order to avoid cavitation.

8.0 Counter Flanges









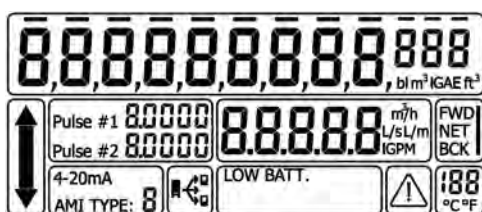

- Refer to the standard dimensional drawings for flange spacing, accommodating for the thickness of gaskets.
- Install meter in line with the pipe axis. The flange faces must be parallel to each other.
- Permissible length deviation: $L_{max} - L_{min}$ 0.5mm (0.02").

9.0 Start-up

- Check that the meter has been installed correctly (Please refer to mechanical installation guide - Page 5).
- Check that the flow rate and volume units are correctly preprogrammed on the display.
- Check that the output module is correctly attached.

10.0 Digital Display Mechanical Data



	Flow direction		System error		Shabbat-Mode
	Flow rate units		Water temperature		Pulse resolution
	Accumulator mode		Volume units		Low battery alert
	Communication mode		Output mode		



Sleep Mode - After 24h (or according to any default chosen) of empty pipe line/ pipe without water the meter will switch to sleep mode.

11.0 Mechanical Data

Maximum Working Pressure	16 bar
Liquid Temperature	0.1 up to 50 °C
Precision Class	ISO 4064 rev.2014, Accuracy class 2
Configuration	Compact - The display is built in to the unit
Power Source	2 D size Li-battery; up to 15 years life time
Environmental Protection	IP 68, Ambient operation temp. -25°C up to +55°C
Volume Display Options	<ol style="list-style-type: none"> 1. Net (Forward less reverse) 2. Forward only 3. Reverse only 4. Forward & reverse alternating
Data Logger	Volumes and alarms data (48KB, 4130 data points)
Connections	1½-2" threaded: with couplings to NPT/ BSP 2"-12" flanged: flanges according to ISO, BS 10 and ANSI 150
Severity levels	Mechanical class M1 Electromagnetic environment class E1
Pressure Loss	ΔP 0.16 bar

Outputs

Analog Output	<p>The Analog Output shows the currently measured flow rate.</p> <p>This output is a 4 - 20 mA current loop (the end user must supply power to the unit).</p> <p>The Analog Output is programmable for forward and reverse flow (see Operation Manual for more details).</p> <p>The 20mA point is programmable per customer request (To any flow lower than the max flow of the meter).</p>										
Digital (pulse) Output	<p>The Digital (pulse) Output is an open drain transistor output that provides pulse per quantity with these options:</p> <ol style="list-style-type: none"> 1. Two scaled forward and/or reverse mode pulses 2. One scaled forward pulse and one alarm frequency output 3. Measuring units of the output can be programmed different than displayed units <p>Pulse resolution will be shown on the display for each pulse separately.</p>										
Dry Contact Output	<p>The Dry Contact Output is a dual mechanical relay output that provides pulse per quantity with these options:</p> <ol style="list-style-type: none"> 1. Two scaled forward and/or reverse mode pulses 2. One scaled forward pulse and one alarm frequency output 3. Measuring units of the output can be programmed different than displayed units <p>Pulse resolution will be shown on the display for each pulse separately.</p> <p>Onsite power supply of 5-35 VDC is needed.</p>										
SSR (Solid State Relay)	<p>The SSR is a dual electronic relay output that provides pulse per quantity with these options:</p> <ol style="list-style-type: none"> 1. Two scaled forward and/ or reverse pulses 2. One scaled forward and one alarm frequency output 3. Measuring units of the output can be programmed different than displayed units <p>Pulse resolution will be shown on the display for each pulse separately.</p> <p>Onsite power supply of 5-35 VDC is needed.</p>										
Encoder Output	<p>The Encoder Output is a serial communication protocol utilizing UI1203 or UI1204 (Sensus protocol).</p> <p>Additional pulse output is available as an option.</p>										
Modbus Protocol Output / M-Bus	<p>The Modbus Protocol Output has the following available functions:</p> <table style="width: 100%; border: none;"> <tr> <td style="width: 50%;">1. Alarms (battery, empty pipe)</td> <td style="width: 50%;">6. Current flow</td> </tr> <tr> <td>2. AMR serial number</td> <td>7. Flow direction</td> </tr> <tr> <td>3. Real Time Clock (RTC)</td> <td>8. Forward and reverse volumes</td> </tr> <tr> <td>4. Volume units</td> <td>9. Flow and volume resolution</td> </tr> <tr> <td>5. Flow rate units</td> <td></td> </tr> </table>	1. Alarms (battery, empty pipe)	6. Current flow	2. AMR serial number	7. Flow direction	3. Real Time Clock (RTC)	8. Forward and reverse volumes	4. Volume units	9. Flow and volume resolution	5. Flow rate units	
1. Alarms (battery, empty pipe)	6. Current flow										
2. AMR serial number	7. Flow direction										
3. Real Time Clock (RTC)	8. Forward and reverse volumes										
4. Volume units	9. Flow and volume resolution										
5. Flow rate units											
Output Extension Cable	5m extension cable for installation in pits and vaults										

Dimensions

Model		Octave									
Nominal size	(mm)	40 Threaded	50 Threaded	50	65	80	100	150	200	250	300
	(inch)	1½ Threaded	2 Threaded	2	2.5	3	4	6	8	10	12
L - Length without couplings (mm)		300	300	200	200	225	250	300	350	449	499
W - Width (mm)		113	113	165	185	200	220	285	340	406	489
H - Height (mm)		155	155	194	210	210	223	282	332	383	456
h - Height (mm)		35	35	40	90	90	103	140	165	203	245
Weight (kg) - cast iron body			8	9	11.5	13	15	32	45	68	96
Weight (kg) - polymer body		1.4	1.45								

Dimensions Stainless Steel Meters (AWWA flanges only)

Model		Octave Stainless Steel				
Nominal size	(mm)	50	80	100	150	200
	(inch)	2	3	4	6	8
L - Length without couplings (mm)		254	305	356	457	508
W - Width (mm)		147	190	229	280	343
H - Height (mm)		165	216	250	276	327
h - Height (mm)		53	90	115	130	162
Weight (kg)- stainless steel body		5.5	11.5	17	27	51

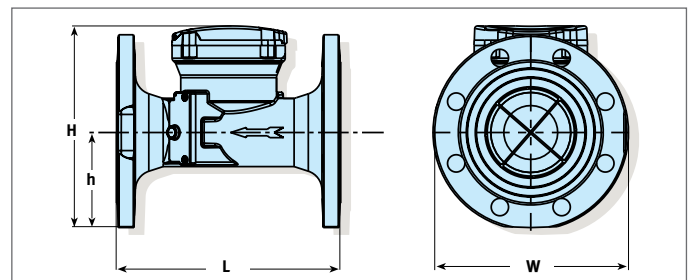
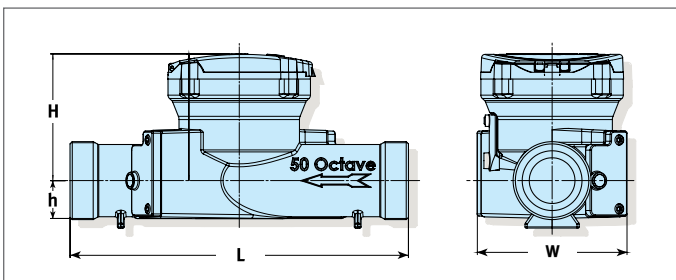

1.0 12.0 Mechanical Data

12.1 Handling the Flow Meter

Important handling information:

- Do not lift the Octave by the electronic housing.
- Do not carry the Octave by its lid.
- Do not place the Octave on the electronic housing.
- When handling the Octave, avoid hard blows, jolts or impacts.

12.2 Installation: Location and Position

Note: The Octave needs to operate with downstream back pressure of minimum 0.5-0.7 Bar. Do not install the meter with a fully open downstream pipe (with no back pressure).

Recommended installation

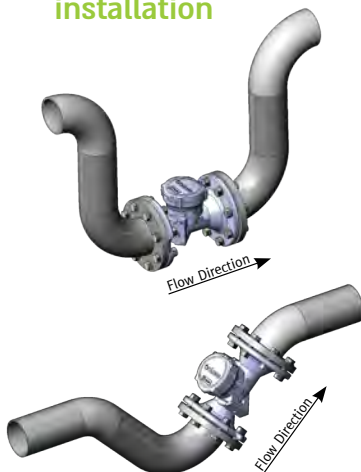

Conditional installation

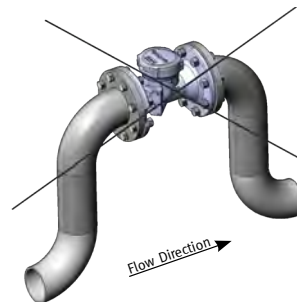

Wrong installation

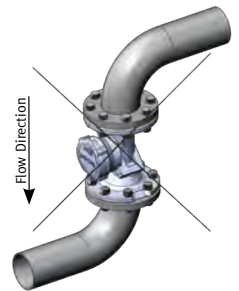

The Following Examples are Arad's Recommendations For Achieving Top Performance

- When installing the Octave downstream of any hydraulic component (valve, pump) the recommended installation requirements are no less than the drawings recommendations. For upstream & downstream straight pipes please use as much as installation site will allow (the longer the better)
- When installing Pressure Breaker after the meter - the pipe length should be at least 2 pipe diameter (the longer the better).

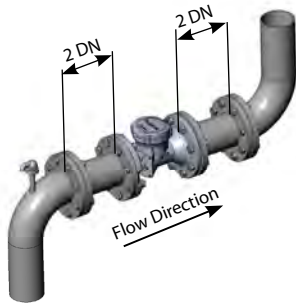

2 pipe diameters before and after elbows (90°)

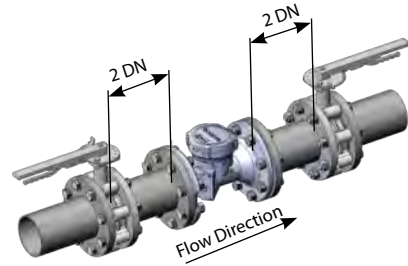

Minimum of two (2) pipe diameters before and after

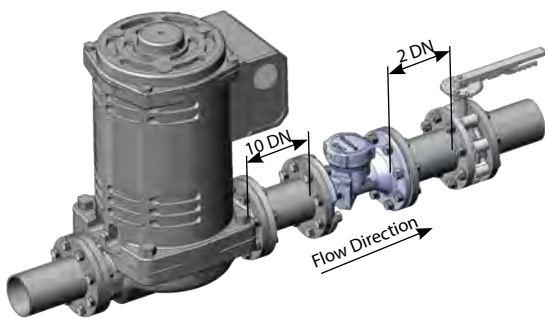

Minimum of ten (10) pipe diameters after pumps

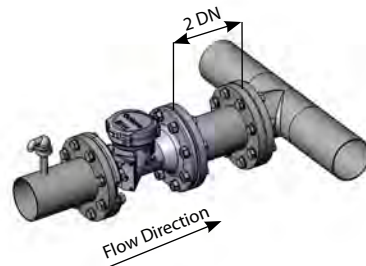

Minimum of two (2) pipe diameters before T connections

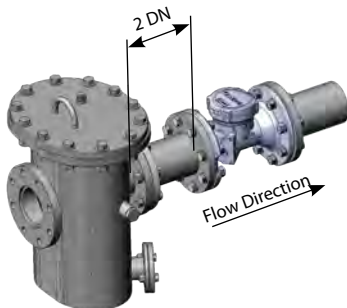

Minimum of two (2) pipe diameters after strainers

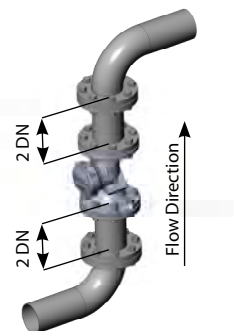

2 pipe diameters before and after elbows (90°) in vertical installations

13.0 Polymeric Octave Installation - General Instructions

Please follow the general instructions for water meters (Check Valve, upstream & down stream and system flushing on new installations).

Existing and new installations:

1. It is recommended that the meter will NOT be installed in the middle of the system, so the meter will not suffer from the load of all the installed fixtures.

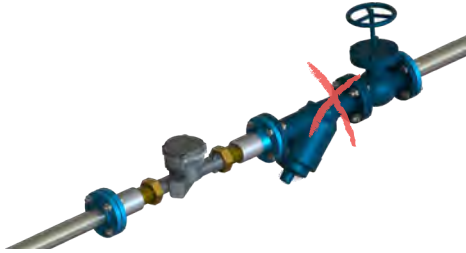

2. It is recommended that at least one side of meter will be connected to a PVC (or plastic) pipe.



3. Please make sure that the end connections are parallel and inline to each other.



4. When using standard tail piece, please use rubber gaskets only (not fiberglass)! After adding the gaskets the gap between the end connection and the meter should not exceed 1mm. Please unscrew the end connection in order to keep the recommended distance.

- Please do not use force in order to close the gap.
- Please don't do any welding while the meter is connected to the pipe.

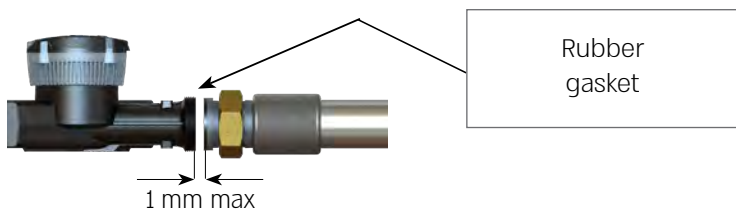

5. If it is not possible to use plastic connections on one side of the meter, please consider the use of our flexible couplings. These couplings were especially developed for the polymeric Octave meters. You will need to use this coupling only on one side of the meter - please install the coupling on the outlet, if possible - as described in the below pictures.

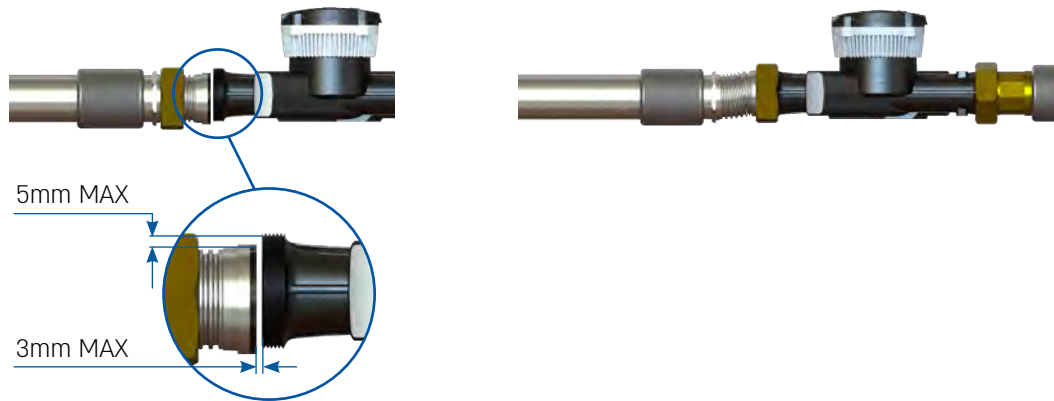

6. Please start to tighten the end connections by hand. Final tightening will be with no more than 100Nm torque.

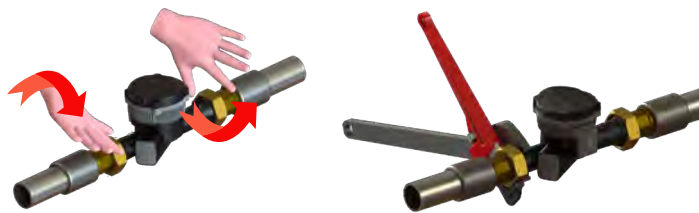

7. Please don't do any welding while the meter is connected to the pipe.



8. In case it is not possible to use plastic end connections (at least on one side), please support the meter as shown in the drawing below.

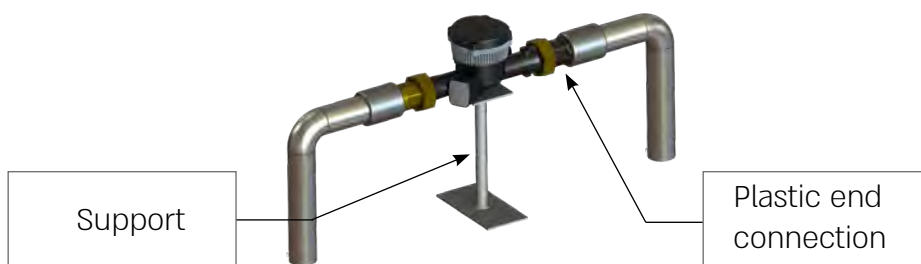

14.0 Electrical Outputs

1. Open Drain dual output
2. Dry Contact dual output
3. SSR dual output
4. Analog output (4-20mA)
5. MODBUS output
6. M - bus output

14.1 Open Drain dual output

Connections Diagram

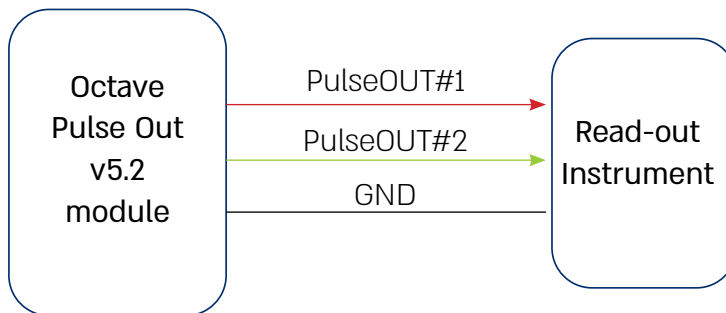

Cables

	Wire	Function
Long cable	Red	Pulse Out#1
	Green	Pulse Out#2
	Black	GND ND

Output Characteristics

Outputs Type	Open Drain
Cable Length - supplied	1.5/5 [meter]
Maximum Cable Length*	500 [meter]
Maximum Applied Voltage	35 [Vdc]
Maximum load	200 [mA]

* Cable Teldor PN 8005003101 or similar

14.2. Dry Contact dual output

Connections Diagram

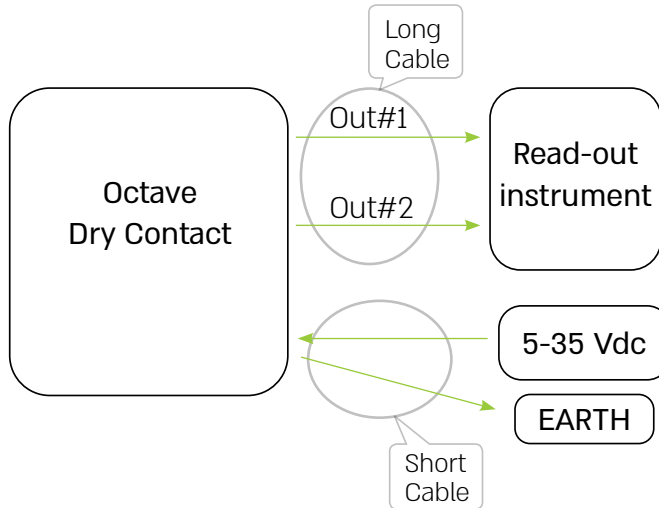

Cables

	Wire	Function
Long cable	Red + Orange	Out#1
	Black + Brown	Out#2
Short cable *	Red	5-35V+
	Black	5-35V-
	Yellow	Earth

* Signal connection polarity is mandatory!

Output Characteristics

Outputs Type	Dry Contact
Cable Length - supplied	1.5/5 [meter]
Maximum Cable Length*	500 [meter]
Supply Voltage	5-35 [Vdc]
Switching Power max.	15 [Watt]
Life Expectancy	10 ⁹ [Cycles]

* Cable Teldor PN 8005003101 or similar

14.3. SSR dual output

Connections Diagram

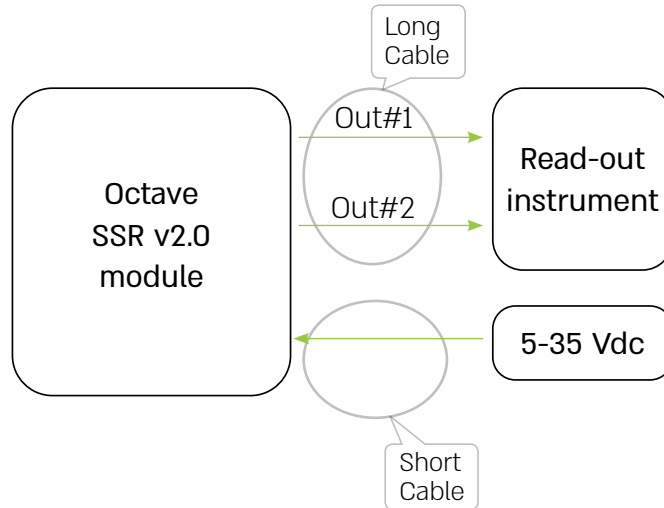

Cables

	Wire	Function
Long cable	Red + Orange	Out#1
	Black + Brown	Out#2
Short cable *	Red	5-35V +
	Black	5-35V -

* Optional

Signal connection polarity is mandatory!

Output Characteristics

Outputs Type	Bi-directional Solid State Relay
On-Resistance max.	25 [Ω]
Minimum Pulse Width	10 [msec]
Output current max.	120 [mA]
Total Power Dissipation max.	800 [mW]
Supply Voltage	5-35 [Vdc]
Cable Length - supplied	1.5 [meter]
Maximum Cable Length*	500 [meter]

* Cable Teldor PN 8005003101 or similar

The SSR module is powered by internal battery.

External power supply in a range of 5-35Vdc could be used for certain Pulse parameters and Flow Rate combination.

Pulse resolution or Pulse width are directly affect the internal battery lifetime.

The following setup examples showing the calculated internal battery lifetime for 10 and 5 years:

10 years	No. of Outputs	Q4 [m3/h]	Pulse Resolution [m3/pulse]	Pulse Width [msec]	Calculated battery lifetime [years]
DN-50	2	50	0.01	30	11.4
	2	50	0.01	30	11.4
DN-80	2	80	0.01	20	10.7
DN-100	2	125	0.01	12	11.4

5 years	No. of Outputs	Q4 [m3/h]	Pulse Resolution [m3/pulse]	Pulse Width [msec]	Calculated battery lifetime [years]
DN-50	2	50	0.001	7	5.1
	2	50	0.01	70	5.1
DN-80	2	80	0.01	45	5.0
DN-100	2	125	0.01	30	4.8

14.4. Analog output 4-20mA

- The current output is a passive 4-20mA. Power needs to be supplied by the customer.
- 4mA is always "0" (zero) flow and the 20mA is programmable according to the customer requirements. (If the customer did not specify, the 20mA will be the maximum flow rate).

14.4.1. Indor installation

Connections Diagram

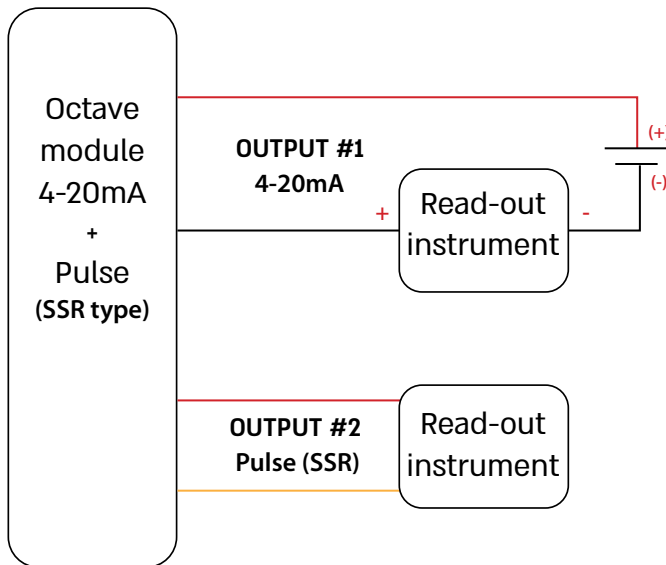

OUTPUT #1 4-20mA

Cables

Wire	Function
Red	current loop +
Black	current loop -

OUTPUT #2 Pulse (SSR)

Cables

	Wire	Function
Long cable	Red	Out#2
	Orange	

Output Characteristics

Outputs Type	4-20mA current output
Supplied Cable Length	1.5 [meter]
Maximum Cable Length*	500 [meter]
Loop supply voltage	12 - 24 [Vdc]
Output Impedance	25 [MΩ] typ

* Cable Teldor PN 8005003101 or similar

Output Characteristics

Outputs Type	Bi-directional Solid State Relay
On-Resistance max.	25 [Ω]
Minimum Pulse Width	10 [msec]
Output current max.	120 [mA]
Total Power Dissipation max.	800 [mW]
Supply Voltage	5-35 [Vdc]
Cable Length - supplied	1.5 [meter]
Maximum Cable Length*	500 [meter]

* Cable Teldor PN 8005003101 or similar

14.4.2. Outdoor installation

Connections Diagram

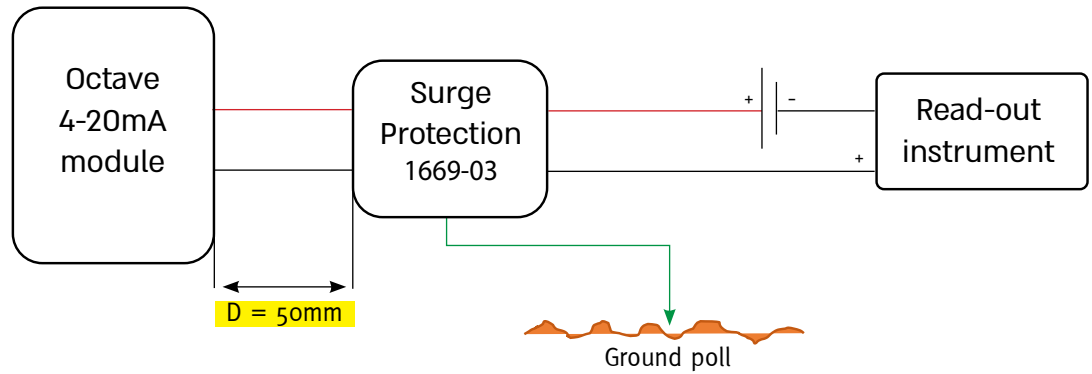

Cables

Wire	Function
Red	current loop +
Black	current loop -

Surge Protector

In regions with potential surge and lightnings it is suggested to add Surge Protector of type - Bourns 1669-03.

Important: Assembly distance from the Octave 20-4mA module - no more than 100mm!

The protector wiring is AWG #20 (0.5 mm²).

The solid colored red and black wires are to be connected to the 4-20mA module output, while the striped red/white and black/white wires (the 'protected' output) connect to the terminals of the field device.

Minimize looping of the solid colored input and ground conductors to reduce field coupling of surges into the protected output.

Grounding

The protector body (stainless steel nipple) and green wire are electrically common.

The green wire should connect to a grounding pole verified by the electricity local company .

The green ground wire should be a 2.5 mm diameter at least

14.5. Modbus output

Connections Diagram

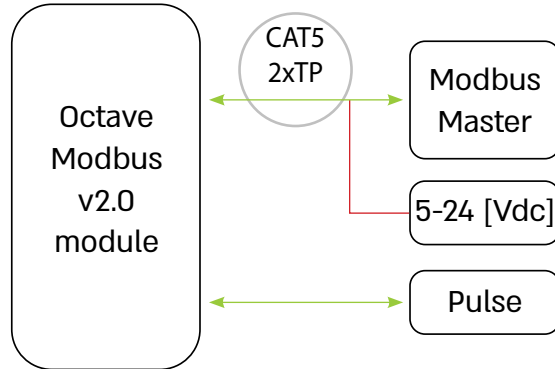

Cables

	Wire	Function
ModBus	Blue	D0/A/Tx+
	White/Blue	D1/B/Tx-
	Orange	5-24Vdc
	White/Orange	Ground
Pulse*	Red	Pulse Out
	Black	Ground

* Optional

Output Characteristics

Outputs Type	RS485
Max Baud Rate	9600 [BPS]
Max Power Consumption	80 [mW]
Supply Voltage Range	5 - 24 [Vdc]
Max Cable Length	1000 [Meter]

* Cable Teldor PN 8005003101 or similar

14.6. M-Bus output

Connections Diagram

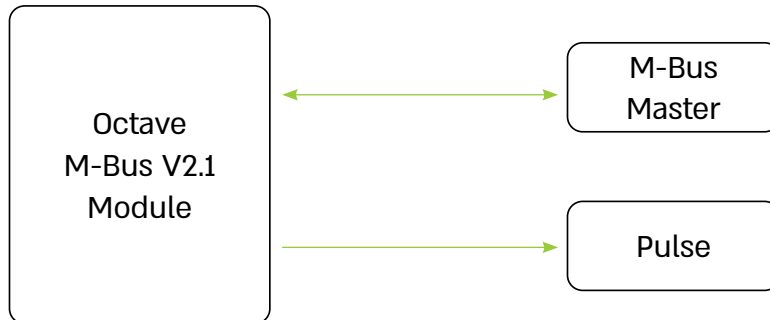

Cables

	Wire	Function
M-Bus	Red	BUSL1
	Black	BUSL2
Pulse*	Red	Pulse Out
	Black	Ground

* Optional

Output characteristics

Outputs Type	M-Bus
Max Baud Rate	9600 [BPS]
Max Power Consumption	80 [mW]
M-Bus Voltage	24 - 36 [Vdc]
Max Cable Length*	3 [Meter]

* Cable Teldor PN 8005003101 or similar

15.0 Module Replacement / Mounting Manual

1. Properly dry the area of the connector.



2. Remove seal cover from the screw using tool with sharp edge.
3. Remove the screws using Allen key 3mm.
4. Remove the module/cover.
5. Properly dry again the area of the connector.
6. Make sure the module o-ring is in position.
If not, Insert new o-ring into the module. The o-ring must be lubricated (silicone grease)



7. Attach module to the connector.



8. Tight both screws by hand only, using Allen key 3 mm to achieve symmetric o-ring pressure, then apply the torque 2 N*m with torque wrench.



9. Insert seal cover onto the screw.





EU Declaration of Conformity

Product line: Octave Ultrasonic Water meters

Sized 40 up to 300 mm



We Arad ltd,

Declare under our sole responsibility, that the above mentioned product line is consistent with the type described in the certificate SK 20-MI001-SMU062 revision 2 (issued 13 November 2020 valid until 14 August 2030) approved by the Notified Body 1781 Slovak Institute of Metrology in accordance with Directives 2014/32/EU Annex II ,Module B.

The quality system for production, final product inspection and testing of the water meters (MI-001) was approved by the Notified Body 1781 Slovak Institute of Metrology in accordance with Directive 2014/32/EU Annex II Module D (Certificate No. SK 20-QD-SMU013 rev.3, issued 30 December 2020 and valid until 20 February 2023.

The object of the declaration described above is in conformity with the requirements of the following directive/s :

Directive 2014/32/EU of the European parliament and of the council of 26 February 2014 on the harmonisation of the laws of the Member States relating to the making available on the market of measuring instruments.
Directive 2014/30/EU of the European parliament and of the council of 26 February 2014 on the harmonisation of the laws of the Member States relating to electromagnetic compatibility.

Harmonized standards and normative documents used:

OIML R 49-1:2006 -Water meters intended for the metering of cold potable water and hot water.
Part 1: Metrological and technical requirements
OIML R 49-2:2004 -Water meters intended for the metering of cold potable water and hot water.
Part 2: Test methods
EN 14154-1:2005+A2:2011 Water meters - Part 1: General requirements
EN 14154-2:2005+A2:2011 Water meters - Part 2: Installation and conditions of use
EN 14154-3:2005+A2:2011 Water meters - Part 3: Test methods and equipment

Other instructions used:

OIML R 49-1:2013 -Water meters intended for the metering of cold potable water and hot water.
Part 1: Metrological and technical requirements.
OIML R 49-2:2013 -Water meters intended for the metering of cold potable water and hot water.
Part 2: Test methods.
OIML R 49-3:2013 -Water meters intended for the metering of cold potable water and hot water.
Part 3: Test report format.
EN ISO 4064-1: 2017 -Water meters for cold potable water and hot water.
Part 1: Metrological and technical requirements
EN ISO 4064-2: 2017 -Water meters for cold potable water and hot water. Part 2: Test methods.
EN ISO 4064-5: 2017 -Water meters for cold potable water and hot water. Part 5: Installation requirements.

Signed for and on behalf of: Arad ltd, Dalia 1923900, Israel
Date : 15/02/2021
Signed by : Nastiya Rubin, Product Certification Manager

Nastiya Rubin
Arad Ltd.

Q:\QMS\Declarations of Conformity\2019\templates\EU Declaration of Conformity OCT 150919 EN.docx

Arad Ltd. | Dalia 1923900, Israel | Tel: 972-4-9897911, Fax: 972-4-9897960 | www.arad.co.il





Specifications are subject to change without notice.

For the most updated version, please check our website: www.arad.co.il

